

7 YR WARRANTY
UK EXCLUSIVE UP TO 7 YEAR MOTOR WARRANTY

SeceuroGlide
Garage Doors

35 YEARS
1985-2020
ANNIVERSARY

SeceuroGlide Retail Price List The Original, Insulated Roller Garage Door

SWS UK



SeceuroGlide Original: Rosewood Woodgrain Finish



SeceuroGlide Manual: Anthracite Colour Finish

An elegantly simple, yet well proven design.

SeceuroGlide is robust, reliable and durable – offering secure protection for your car and home.

A choice of low maintenance finishes, insulation and the convenience of remote automatic operation powered by a high quality SeceuroDrive Motor as standard make SeceuroGlide an excellent all round choice.

SeceuroGlide's aluminium slats lock into position to resist attack by intruders, while advanced insulation and brush sealing keeps out the cold and makes the door as weatherproof as it is secure. Vertical opening means you can make maximum use of your drive and garage space – parking safely just inches from the door.

SeceuroGlide garage doors are supplied complete with your choice of remote control, Seceurosense Plus or Somfy Rollixo. You'll have a choice of handsets and the control equipment will include a courtesy light, bottom slat transmitter, safety edge and manual controls to operate the garage door..

A wide choice of finishes including Woodgrain and Painted Woodgrain help you to match your door to existing paintwork or woodgrain double glazing for a coherent look to your home's exterior. Our SeceuroGlide Original and SeceuroGlide Excel is also available powder coated to any RAL or BS number for a surcharge.

SeceuroGlide Excel combines all the benefits of SeceuroGlide Original with an even higher security specification, and is officially tested and approved to Police and insurance standards. Available at a surcharge on the price of a SeceuroGlide Original.

 **SeceuroGlide | Original**
Secure, Insulated Garage Doors

 **SeceuroGlide | Excel**
High Security, Insulated Garage Doors

 **SeceuroGlide | LT**
Standard, Insulated Garage Door

 **SeceuroGlide | Compact**
Low Headroom, Insulated Garage Door

 **SeceuroGlide | Manual**
Insulated Roller Garage Doors

 **SeceuroGlide | Vertico**
Secure, Vertical, Insulated Garage Doors

EXPLORE THE DIFFERENCES

SeceuroGlide | LT Standard, Insulated Garage Door



Aluminium End Plate

Standard, aluminium cast end plate.



Standard Locking System

A 70mm axle alongside plastic and steel locking straps secure your standard SeceuroGlide LT.



Endlocks

Crimped and stapled endlocks used to secure the curtain in operation.

SeceuroGlide | Original Secure, Insulated Garage Doors

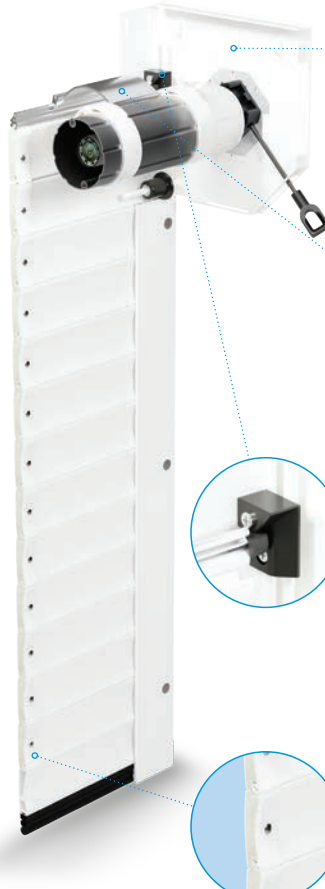

Steel End Plates

Steel end plates on the SeceuroGlide Original & Excel provide a sturdier design and increased security when compared with aluminium end plates.

Strength & Security

100 mm fluted axle, extruded aluminium hinges & top rail, provide greater strength when the door is in operation and in the locked position.

Unique Locking System

Both the Original and the Excel come with auto locking as standard for greater security, preventing the door from being lifted by an intruder. Centralised locking blocks ensure better running of the door during operation.

Security & Noise Reduction

Webbing on each side of the curtain provides additional security whilst also reducing the noise made by the curtain in operation.

SeceuroGlide | Excel High Security, Insulated Garage Doors



Reveal Fit

The SeceuroGlide Excel boasts Secured by Design and insurance approved Level One Security Rating for internal face and reveal fixtures.

Secured by Design

Upgraded 90 mm channels as standard, work alongside locking bottom slats to provide greater security, one of many features which make this door accredited by Secured by Design, even on between fit installations. Locking bottom slat on the SeceuroGlide Excel is designed to prevent the door being pushed out of the guides by an intruder.

SECURE



VERY SECURE



ULTRA SECURE



SeceuroGlide | Original
Secure, Insulated Garage Doors

SeceuroGlide | Excel
High Security, Insulated Garage Doors



SeceuroGlide Original: Anthracite Colour Finish



SeceuroGlide Excel: White Colour Finish

Exceptional design and security.

Since the introduction of our hugely popular SeceuroGlide Original back in 1997, we have gone on to develop a series of garage doors which address everything from security and strength, to aesthetics, clever design and ease of use. In addition to the Secured by Design accreditation of the Original, the Excel also meets the higher specification set by the LPCB to create the most advanced roller door on the market.

Profiles & Sizes

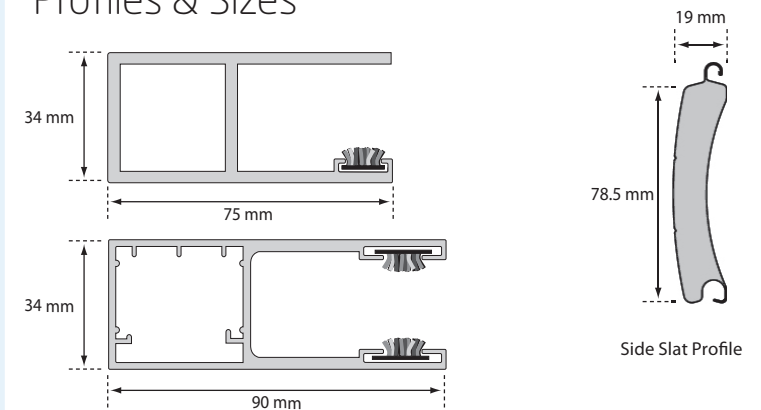

SeceuroGlide Excel guide rail notes:

- 90 mm guide rails supplied as standard on SeceuroGlide Excel.
- Reveal fitted guide rails require steel reinforcement plates.



Unique locking system

Both the Original and the Excel come with auto locking as standard for greater security.



Webbing

Webbing provides additional security, weatherproofing and noise reduction.

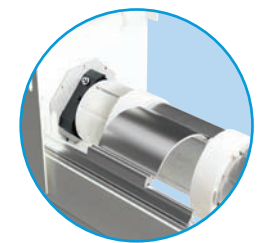

Strength and Security

100 mm fluted axle, extruded aluminium hinges and top rail make for a secure operation.

Standard Colours	Overall Guide Width (mm)											Excel max. width	
	NO BOX	1500	2000	2500	3000	3500	4000	4600	5200	5400	5590	Headroom	Total Height
	Guide Width*	75	75	75	75	75	75	75	90	90	90		
Guide Height (mm)	1900	1417	1572	1729	1894	2010	2298	2564	2850	2886	2922	300	2200
	2150	1479	1610	1741	1918	2046	2333	2594	2903	2983		300	2450
	2300	1518	1661	1774	1953	2083	2372	2651	2946	3226		300	2600
	2500	1590	1734	1840	2091	2140	2472	2826	3093	3335		300	2800
	3000	1705	1911	2099	2258	2303	2678	3056	3303			350	3350
	3500	1879	2036	2240	2472	2466	3011					350	3850
	3700	2053	2160	2380	2686	2630	3344					350	4050

*SeceuroGlide Excel will always be supplied with 90 mm guides

Excel max. height

Woodgrain Colours	Overall Guide Width (mm)											Excel max. width	
	NO BOX	1500	2000	2500	3000	3500	4000	4600	5200	5400	5590	Headroom	Total Height
	Guide Width*	75	75	75	75	75	75	75	90	90	90		
Guide Height (mm)	1900	1557	1756	1960	2171	2341	2673	2995	3335	3392	3447	300	2200
	2150	1635	1816	2018	2243	2421	2757	3097	3454	3554		300	2450
	2300	1685	1883	2060	2285	2479	2825	3170	3534	3838		300	2600
	2500	1699	1975	2144	2453	2570	2920	3392	3734	3998		300	2800
	3000	1924	2203	2465	2695	2821	3269	3734	4069			350	3350
	3500	2133	2374	2664	2981	3071	3619					350	3850
	3700	2341	2545	2862	3267	3322	3969					350	4050

*SeceuroGlide Excel will always be supplied with 90 mm guides

Excel max. height

STANDARD COLOURS



Burgundy (RAL 3004)	Navy Blue (RAL 5011)	Light Beige (BS 08B17)	Brown (RAL 8014)	Fir Green (RAL 6009)	Black (RAL 9005)
White (RAL 9016)	Silver Metallic (RAL 9006)	Anthracite (RAL 7016)	Graphite	Heritage Green (RAL 6021)	Ivory (RAL 1015)
Light Grey (RAL 7038)	Duck Egg Blue	Chartwell Green	Walnut	Natural Oak	

Powder coated guide rails, bottom slats and vision slats (where specified) to match the curtain colour are supplied as standard.

End Plates: Galvanised finish as standard. Other colour options are available at a surcharge of **£24.67 per pair**.

Guides Rails: Other non standard colours available at **£36.86 per pair**.

For Painted Woodgrains we will use these RAL numbers: Walnut RAL 8014, Natural Oak RAL 1011.

FOILED WOODGRAIN COLOURS



Rosewood	Mahogany	Golden Oak	White	Black/Brown

Powder coated guide rails, bottom slats and vision slats (where specified) are supplied brown as standard.

End Plates: Galvanised, white, brown or black as standard. Other colour options are available at a surcharge of **£24.67 per pair**.

Guides Rails: Other non standard colours available at **£36.86 per pair**.

Woodgrain finishes are supplied on one face only on brown slats as standard or white on request (Other base colours available at a cost of £35.88 per square metre NET).

Premier finishes are also available at a surcharge additional to the price shown of £17.37 per square metre.

DON'T FORGET!
We can match your existing doors or windows!



For the ultimate choice, we can colour match to any RAL or BS colour.
From **£71.82 per square metre** (including colour matched guides, box and end plates where applicable)

Depending on RAL colour selected there may be a minimum powder coating surcharge to be applied.

EXCEL UPGRADE

Face fit guide rails **£114.47 (pair)**
Reveal fit guide rails **£158.44 (pair)**

Secured by Design

Assessed to ISO 9001 & ISO 14001
Certified by LPCB ref. 306

SECEURODRIVE MOTOR

Supplied as standard: FOC



SOMFY MOTOR

Available with a surcharge: **£30 net**



CONTROL OPTIONS

Supplied as standard – choose ONE of the following:

SECEUROGLIDE | SECEUROSENSE PLUS

SOMFY | ROLLIXO

ALARM SURCHARGE

SECEUROSENSE PLUS
£85.72

SOMFY | ROLLIXO
Included

Standard Colours	Overall Guide Width (mm)											Excel max. width	
	HALF BOX	1500	2000	2500	3000	3500	4000	4600	5200	5400	5590	Headroom	Total Height
	Guide Width*	75	75	75	75	75	75	75	90	90	90		
Guide Height (mm)	1900	1467	1642	1847	2034	2174	2481	2776	3088	3134	3179	300	2200
	2150	1528	1675	1875	2069	2208	2515	2820	3140	3229		300	2450
	2300	1564	1730	1901	2091	2242	2554	2861	3184	3474		300	2600
	2500	1592	1800	1957	2231	2301	2594	3037	3332	3583		300	2800
	3000	1771	2030	2249	2435	2511	2924	3266	3545			350	3350
	3500	1970	2156	2388	2650	2721	3326					350	3850
	3700	2169	2281	2528	2866	2932	3728					350	4050

*SeceuroGlide Excel will always be supplied with 90 mm guides

Excel max. height

Woodgrain Colours	Overall Guide Width (mm)											Excel max. width	
	HALF BOX	1500	2000	2500	3000	3500	4000	4600	5200	5400	5590	Headroom	Total Height
	Guide Width*	75	75	75	75	75	75	75	90	90	90		
Guide Height (mm)	1900	1599	1818	2055	2309	2494	2848	3197	3564	3629	3695	300	2200
	2150	1680	1877	2123	2381	2574	2932	3297	3679	3791		300	2450
	2300	1726	1946	2145	2426	2631	2999	3371	3763	4073		300	2600
	2500	1767	2035	2221	2552	2723	3173	3592	3959	4234		300	2800
	3000	2013	2319	2613	2871	3016	3451	3871	4231			350	3350
	3500	2204	2496	2812	3159	3310	3911					350	3850
	3700	2394	2672	3012	3447	3603	4372					350	4050

*SeceuroGlide Excel will always be supplied with 90 mm guides

Excel max. height

STANDARD COLOURS



5 YR

Powder coated guide rails, bottom slats and vision slats (where specified) to match the curtain colour are supplied as standard.

Box & End Plates: White or brown as standard. Other colour options are available at a surcharge of **£28.13 per metre** (includes end plates).

Guides Rails: Other non standard colours available at **£36.86 per pair**.

For Painted Woodgrains we will use these RAL numbers: Walnut RAL 8014, Natural Oak RAL 1011.

FOILED WOODGRAIN COLOURS

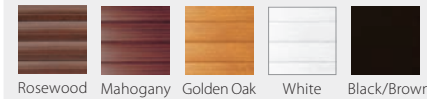

10 YR

Powder coated guide rails, bottom slats and vision slats (where specified) are supplied brown as standard.

Box: White or brown as standard. Other colour options are available at a surcharge of **£28.05 per metre**.

End Plates: Galvanised, white, brown or black as standard. Other colour options are available at a surcharge of **£24.60 per pair**.

Guides Rails: Other non standard colours available at **£36.76 per pair**.

Woodgrain finishes are supplied on one face only on brown slats as standard or white on request (Other base colours available at a cost of **£35.88 per square metre NET**).

Premier finishes are also available at a surcharge additional to the price shown of **£17.32 per square metre**.



For the ultimate choice, we can colour match to any RAL or BS colour.

From **£71.82 per square metre** (including colour matched guides, box and end plates where applicable)

Depending on RAL colour selected there may be a minimum powder coating surcharge to be applied.

EXCEL UPGRADE

Face fit guide rails **£114.47 (pair)**
Reveal fit guide rails **£158.44 (pair)**



SECEURODRIVE MOTOR

Supplied as standard: FOC

SOMFY MOTOR

Available with a surcharge of **£30 net**

CONTROL OPTIONS

Supplied as standard – choose ONE of the following:

SECEUROGLIDE | SECEUROSENSE PLUS
SOMFY | ROLLIXO

ALARM SURCHARGE

SECEUROSENSE PLUS
£85.72
SOMFY | ROLLIXO
Included

HALF BOX OPTIONS



Standard Colours	Overall Guide Width (mm)											Excel max. width	
	FULL BOX	1500	2000	2500	3000	3500	4000	4600	5200	5400	5590	Headroom	Total Height
	Guide Width*	75	75	75	75	75	75	75	90	90	90		
Guide Height (mm)	1900	1476	1664	1857	2056	2211	2526	2831	3156	3207	3258	300	2200
	2150	1533	1698	1883	2092	2245	2559	2874	3205	3299		300	2450
	2300	1569	1750	1911	2114	2279	2598	2914	3247	3529		300	2600
	2500	1596	1817	1961	2246	2332	2651	3079	3385	3633		300	2800
	3000	1808	2070	2311	2525	2631	2949	3299	3587			350	3350
	3500	1973	2186	2444	2728	2930	3248					350	3850
	3700	2138	2303	2576	2930	3227	3547					350	4050

*SeceuroGlide Excel will always be supplied with 90 mm guides

Excel max. height

Woodgrain Colours	Overall Guide Width (mm)											Excel max. width	
	FULL BOX	1500	2000	2500	3000	3500	4000	4600	5200	5400	5590	Headroom	Total Height
	Guide Width*	75	75	75	75	75	75	75	90	90	90		
Guide Height (mm)	1900	1610	1843	2080	2322	2514	2873	3231	3608	3677	3914	300	2200
	2150	1686	1900	2134	2393	2589	2953	3326	3717	3830		300	2450
	2300	1731	1964	2177	2433	2649	3017	3398	3794	4098		300	2600
	2500	1772	2050	2252	2593	2733	3107	3606	3981	4252		300	2800
	3000	2020	2349	2662	2944	3109	3498	3930	4300			350	3350
	3500	2219	2512	2850	3217	3674	4083					350	3850
	3700	2419	2676	3039	3490	3862	4278					350	4050

*SeceuroGlide Excel will always be supplied with 90 mm guides

Excel max. height

STANDARD COLOURS **5** YR

Powder coated guide rails, bottom slats and vision slats (where specified) to match the curtain colour are supplied as standard.

Box & End Plates: White or brown as standard. Other colour options are available at a surcharge of **£49.41 per metre** (includes end plates).

Guides Rails: Other non standard colours available at **£36.76 per pair**.

For Painted Woodgrains we will use these RAL numbers: Walnut RAL 8014, Natural Oak RAL 1011.

FOILED WOODGRAIN COLOURS **10** YR

Powder coated guide rails, bottom slats and vision slats (where specified) are supplied brown as standard.

Box: White or brown as standard. Other colour options are available at a surcharge of **£49.41 per metre**.

End Plates: Galvanised, white, brown or black as standard. Other colour options are available at a surcharge of **£24.60 per pair**.

Guides Rails: Other non standard colours available at **£36.76 per pair**.

Woodgrain finishes are supplied on one face only on brown slats as standard or white on request (Other base colours available at a cost of £35.88 per square metre NET).

Premier finishes are also available at a surcharge additional to the price shown of £17.32 per square metre.

DON'T FORGET!
We can match your existing doors or windows!

For the ultimate choice, we can colour match to any RAL or BS colour.
From **£71.82 per square metre** (including colour matched guides, box and end plates where applicable)

Depending on RAL colour selected there may be a minimum powder coating surcharge to be applied.

EXCEL UPGRADE

Face fit guide rails **£114.47 (pair)**
Reveal fit guide rails **£158.44 (pair)**

Secured by Design

Police Preferred Specification

Assessed to ISO 9001 & ISO 14001
Certified to LPCB ref. 306

SECEURODRIVE MOTOR

Supplied as standard: FOC

SOMFY MOTOR

Available with a surcharge: **£30 net**

CONTROL OPTIONS

Supplied as standard – choose ONE of the following:

SECEUROGLIDE | SECEUROSENSE PLUS

SOMFY | ROLLIXO

ALARM SURCHARGE

SECEUROSENSE PLUS
£85.72

SOMFY | ROLLIXO
Included

FULL BOX OPTIONS

Optional Box

'Distance A' = 300 mm
'Distance B' = 350 mm*

* 90° section of 350 mm box comes in 2 parts



SeceuroGlide LT: Fir Green Colour Finish



SeceuroGlide LT: Black Colour Finish

The versatile roller garage door.

The entry level SeceuroGlide LT has been created as the perfect solution for those wanting to invest in the look and feel of the SeceuroGlide Original but without a need for all of the high security benefits and built-in noise reduction features offered by the standard SeceuroGlide product. Combining space saving vertical operation with the benefits of an insulated profile and the convenience of electrical operation the SeceuroGlide LT provides a made to measure solution to give lasting value to your property.

Profiles & Sizes

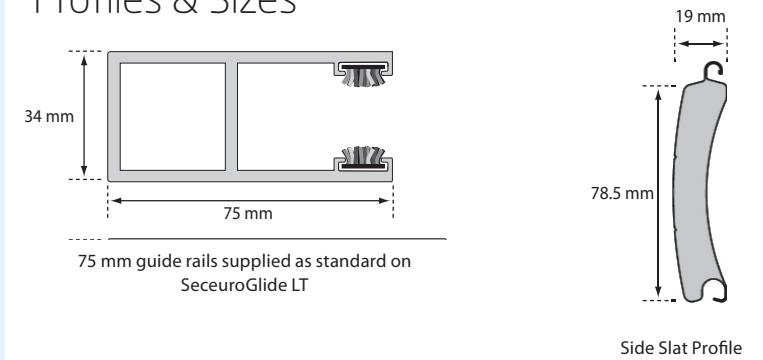

Aluminium End Plate
Standard, aluminium cast end plate.



Standard Locking System
Plastic and steel locking straps secure your standard SeceuroGlide LT.



Endlocks
Endlocks used to secure the curtain in operation.

Overall Guide Width (mm)

Standard Colours	NO BOX	2000	2400	2600	3000	3600	4000	4500	4800	5200	Headroom	Total Height
	Guide Width	75	75	75	75	75	75	75	90	90		
Guide Height (mm)	1900	1473	1548	1581	1628	1723	1822	2079	2194	2239	300	2200
	2150	1503	1591	1632	1668	1803	1979	2234	2348	2460	300	2450
	2300	1574	1628	1685	1727	1869	2025	2283	2404	2506	300	2600
	2500	1616	1651	1733	1818	1896	2061	2313	2470		300	2800
	2650	1660	1723	1806	1857	1931	2095	2374	2489		300	2950

Overall Guide Width (mm)

Woodgrain Colours	NO BOX	2000	2400	2600	3000	3600	4000	4500	4800	5200	Headroom	Total Height
	Guide Width	75	75	75	75	75	75	75	90	90		
Guide Height (mm)	1900	1674	1809	1877	2042	2264	2399	2594	2704	2741	300	2200
	2150	1760	1910	2016	2185	2343	2541	2733	2802	2882	300	2450
	2300	1815	1991	2085	2209	2425	2654	2864	2925	3014	300	2600
	2500	1877	2078	2182	2353	2593	2792	2937	3061		300	2800
	2650	1936	2143	2253	2455	2622	2837	2987	3118		300	2950

STANDARD COLOURS



Powder coated bottom slats and vision slats (where specified) to match the curtain colour are supplied as standard.

End Plates: Aluminium, white or brown as standard. Other colour options are available at a surcharge of **£24.67 per pair**.

Guides Rails: White or Brown as standard. Other colour options are available at a surcharge of **£36.76 per pair**.

For Painted Woodgrains we will use these RAL numbers: Walnut RAL 8014, Natural Oak RAL 1011.



FOILED WOODGRAIN COLOURS

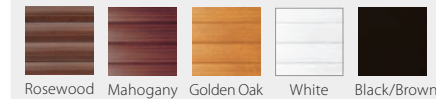

Powder coated guide rails, bottom slats and vision slats (where specified) are supplied brown as standard.

End Plates: Aluminium, white or brown as standard. Other colour options are available at a surcharge of **£24.67 per pair**.

Guides Rails: White or Brown as standard. Other colour options are available at a surcharge of **£36.76 per pair**.



SECEURODRIVE MOTOR

Supplied as standard: FOC **SeceuroDrive** Tubular Motor

SOMFY MOTOR

Available with a surcharge: **£30 net**

CONTROL OPTIONS

Supplied as standard – choose ONE of the following:

SECEUROGLIDE | SECEUROSENSE PLUS

SOMFY | ROLLIXO

ALARM SURCHARGE

SECEUROSENSE PLUS

£85.72

SOMFY | ROLLIXO

Included

Overall Guide Width (mm)

Standard Colours	HALF BOX	2000	2400	2600	3000	3600	4000	4500	4800	5200	Headroom	Total Height	
	Guide Width	75	75	75	75	75	75	75	90	90			
Guide Height (mm)	1900	1502	1622	1617	1748	1919	2021	2173	2258	2266	300	2200	
	2150	1543	1696	1755	1865	2014	2150	2327	2380	2415	300	2450	
	2300	1584	1749	1802	1901	2101	2229	2396	2425	2479	300	2600	
	2500	1642	1776	1863	1956	2166	2321	2446	2508			300	2800
	2650	1679	1796	1910	2031	2205	2385	2480	2602			300	2950

STANDARD COLOURS

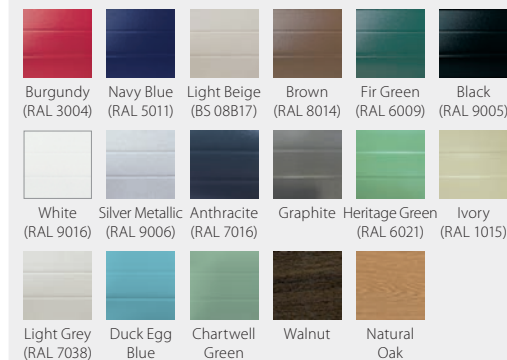

Powder coated bottom slats and vision slats (where specified) to match the curtain colour are supplied as standard.

Box: White or Brown as standard. Other colour options are available at a surcharge of **£28.05 per metre**.

End Plates: Aluminium, white or brown as standard. Other colour options are available at a surcharge of **£24.60 per pair**.

Guides Rails: White or Brown as standard. Other colour options are available at a surcharge of **£36.76 per pair**.

For Painted Woodgrains we will use these RAL numbers: Walnut RAL 8014, Natural Oak RAL 1011.



Overall Guide Width (mm)

Woodgrain Colours	HALF BOX	2000	2400	2600	3000	3600	4000	4500	4800	5200	Headroom	Total Height	
	Guide Width	75	75	75	75	75	75	75	90	90			
Guide Height (mm)	1900	1767	1919	1995	2177	2425	2577	2793	2916	2968	300	2200	
	2150	1828	2021	2135	2322	2503	2765	2984	3069	3170	300	2450	
	2300	1882	2093	2205	2401	2569	2817	3117	3193	3303	300	2600	
	2500	1972	2149	2304	2491	2686	2880	3190	3331			300	2800
	2650	2032	2256	2374	2594	2792	2983	3240	3388			300	2950

FOILED WOODGRAIN COLOURS

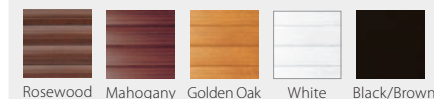

Powder coated guide rails, bottom slats and vision slats (where specified) are supplied brown as standard.

Box: White or brown as standard. Other colour options are available at a surcharge of **£28.05 per metre**.

End Plates: Aluminium, white or brown as standard. Other colour options are available at a surcharge of **£24.60 per pair**.

Guides Rails: White or Brown as standard. Other colour options are available at a surcharge of **£36.76 per pair**.

*Woodgrain finishes are supplied on one face only on brown slats as standard or white on request (Other base colours available at a cost of **£35.88 per square metre NET**).*

*Premier finishes are also available at a surcharge additional to the price shown of **£17.32 per square metre**.*



SECEURODRIVE MOTOR

Supplied as standard: FOC SeceuroDrive Tubular Motor

SOMFY MOTOR

Available with a surcharge: **£30 net** somfy.

CONTROL OPTIONS

Supplied as standard – choose ONE of the following:

SECEUROGLIDE | SECEUROSENSE PLUS

SOMFY | ROLLIXO

ALARM SURCHARGE

SECEUROSENSE PLUS

£85.72

SOMFY | ROLLIXO
Included

HALF BOX OPTIONS

300 mm box 90° fascia

300 mm box 45° box cover



BOX MADE UP AS STANDARD

Boxes for SeceuroGlide LT come made up as standard.

If you do not wish to take advantage of this manufacturing process, there will be a **£15 net discount**.

Overall Guide Width (mm)

Standard Colours	FULL BOX	2000	2400	2600	3000	3600	4000	4500	4800	5200	Headroom	Total Height
	Guide Width	75	75	75	75	75	75	75	90	90		
Guide Height (mm)	1900	1525	1648	1697	1841	2032	2146	2367	2409	2430	300	2200
	2150	1583	1763	1823	1973	2163	2275	2505	2495	2556	300	2450
	2300	1620	1808	1880	2032	2213	2353	2549	2578	2643	300	2600
	2500	1659	1825	1911	2069	2277	2445	2584	2658		300	2800
	2650	1701	1869	1959	2123	2317	2494	2606	2676		300	2950

STANDARD COLOURS



5 YR

Powder coated bottom slats and vision slats (where specified) to match the curtain colour are supplied as standard.

Box: White or Brown as standard. Other colour options are available at a surcharge of **£49.41 per metre**.

End Plates: Aluminium, white or brown as standard. Other colour options are available at a surcharge of **£24.60 per pair**.

Guides Rails: White or Brown as standard. Other colour options are available at a surcharge of **£36.76 per pair**.

For Painted Woodgrains we will use these RAL numbers: Walnut RAL 8014, Natural Oak RAL 1011.

Overall Guide Width (mm)

Woodgrain Colours	FULL BOX	2000	2400	2600	3000	3600	4000	4500	4800	5200	Headroom	Total Height
	Guide Width	75	75	75	75	75	75	75	90	90		
Guide Height (mm)	1900	1831	1997	2079	2275	2396	2709	2941	3075	3141	300	2200
	2150	1883	2080	2219	2325	2471	2897	3133	3228	3342	300	2450
	2300	1932	2141	2289	2386	2533	3011	3264	3351	3475	300	2600
	2500	1989	2213	2387	2548	2617	3090	3338	3488		300	2800
	2650	2270	2417	2458	2706	2963	3199	3387	3545		300	2950

FOILED WOODGRAIN COLOURS

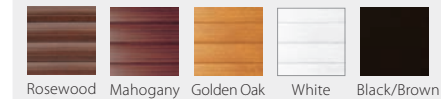

10 YR

Woodgrain finishes are supplied on one face only on brown slats as standard or white on request (Other base colours available at a cost of £35.88 per square metre NET).

Premier finishes are also available at a surcharge additional to the price shown of £17.32 per square metre.

Powder coated guide rails, bottom slats and vision slats (where specified) are supplied brown as standard.

Box: White or brown as standard. Other colour options are available at a surcharge of **£49.41 per metre**.

End Plates: Aluminium, white or brown as standard. Other colour options are available at a surcharge of **£24.60 per pair**.

Guides Rails: White or Brown as standard. Other colour options are available at a surcharge of **£36.76 per pair**.

SECEURODRIVE MOTOR

Supplied as standard: FOC SeceuroDrive Tubular Motor

SOMFY MOTOR

Available with a surcharge: **£30 net** somfy.

CONTROL OPTIONS

Supplied as standard – choose ONE of the following:

- SECEUROGLIDE | SECEUROSENSE PLUS**
- SOMFY | ROLLIXO**

ALARM SURCHARGE

SECEUROSENSE PLUS

£85.72

SOMFY | ROLLIXO
Included

FULL BOX OPTIONS

'Distance A' = 300 mm

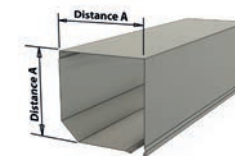

BOX MADE UP AS STANDARD

Boxes for SeceuroGlide LT come made up as standard.

If you do not wish to take advantage of this manufacturing process, there will be a **£15 net discount**.



SeceuroGlide Compact: White Colour Finish



SeceuroGlide Compact: White Colour Finish

SeceuroGlide Compact internal/external fitting roller garage door.

The SeceuroGlide Compact has been developed especially for garages with limited headroom. SeceuroGlide Compact's insulated aluminium slats are narrower than those used for the SeceuroGlide allowing a tighter, smaller coil which requires just 8" (205 mm) clearance above the opening height. An extensive range of sizes also means openings of up to 3000 mm wide (Overall Guide Width) can be accommodated.

Profiles & Sizes

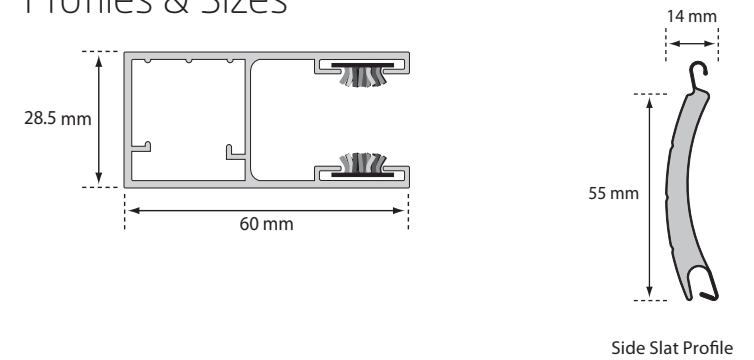

End Plate

The Compact features a rugged locking system for peace-of-mind security.



Slimline Design

The Compact's slimline slat is fully insulated, yet has an exposed face just 55 mm high.

Overall Guide Width (mm)

Standard Colours	Overall Guide Width (mm)			Headroom	Total Height
	HALF BOX	2000	2500		
	Guide Width	60	60	60	
	Guide Height (mm)	1900	1653	1756	205
	2150	1682	1775	205	2355
FULL BOX			Headroom	Total Height	
Guide Width	60	60			60
Guide Height (mm)	1900	1698	1795	205	2105
	2150	1722	1822	205	2355

Overall Guide Width (mm)

Woodgrain Colours	Overall Guide Width (mm)			Headroom	Total Height
	HALF BOX	2000	2500		
	Guide Width	60	60	60	
	Guide Height (mm)	1900	1834	1984	205
	2150	1884	2041	205	2355
FULL BOX			Headroom	Total Height	
Guide Width	60	60			60
Guide Height (mm)	1900	1869	2011	205	2105
	2150	1914	2070	205	2355

STANDARD COLOURS



Powder coated bottom slats to match the curtain colour are supplied as standard.

Half Box: White, Brown or Fir Green as standard. Other colour options are available at a surcharge of **£28.05 per metre**.

Full Box: White, Brown or Fir Green as standard. Other colour options are available at a surcharge of **£49.41 per metre**.

End Plates: White, Brown or Fir Green as standard. Other colour options are available at a surcharge of **£24.60 per pair**.

Guides Rails: White, Brown or Fir Green as standard. Other colour options are available at a surcharge of **£36.76 per pair**.

FOILED WOODGRAIN COLOURS

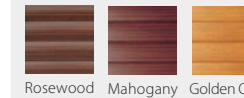

Powder coated guide rails and bottom slats are supplied brown as standard.

Half Box: White, Brown or Fir Green as standard. Other colour options are available at a surcharge of **£28.05 per metre**.

Full Box: White, Brown or Fir Green as standard. Other colour options are available at a surcharge of **£49.41 per metre**.

End Plates: White, Brown or Fir Green as standard. Other colour options are available at a surcharge of **£24.60 per pair**.

Guides Rails: White, Brown or Fir Green as standard. Other colour options are available at a surcharge of **£36.76 per pair**.

Woodgrain finishes are supplied on one face only on brown slats as standard or white on request (Other base colours available at a cost of £35.88 per square metre NET).

Premier finishes are also available at a surcharge additional to the price shown of £17.32 per square metre.

SECEURODRIVE MOTOR

Supplied as standard: FOC **SeceuroDrive**
Tubular Motor

SOMFY MOTOR

Available with a surcharge: **£30 net** **somfy**

CONTROL OPTIONS

Supplied as standard – choose ONE of the following:

SECEUROGLIDE | SECEUROSENSE PLUS

SOMFY | ROLLIXO

ALARM SURCHARGE

SECEUROSENSE PLUS

£85.72

SOMFY | ROLLIXO
Included

HALF BOX OPTIONS

205 mm box 90° fascia



FULL BOX OPTIONS

'Distance A'
= 205 mm

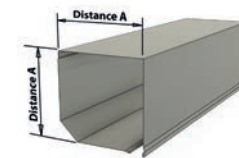



SeceuroGlide Manual: Light Grey Colour Finish



SeceuroGlide Manual: Anthracite Colour Finish

SeceuroGlide Manual the only insulated manual roller garage door on the market.

Developed to the same high standards and build quality as the SeceuroGlide range, SeceuroGlide Manual offers the ideal solution for applications where electricity is not available. The SeceuroGlide Manual has been engineered with ease of use in mind to provide the smoothest operation, whilst still offering the high levels of security and insulation.

Profiles & Sizes

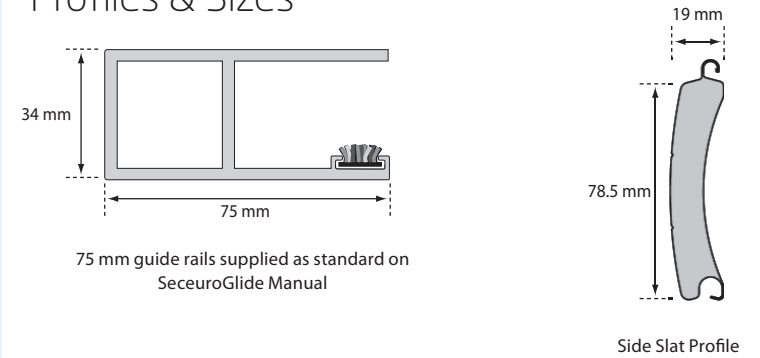

Smooth Operation
The rolling bracket ensures smooth operation and reduces wear.

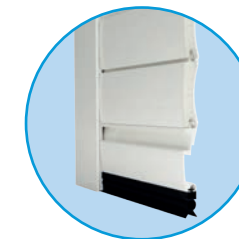

Strengthening Bottom Slat
Patented bottom slat profile provides strength and aids operation.



Insulated Slats
Foam filled aluminium slats.

Overall Guide Width (mm)

Standard Colours	NO BOX	1000	1500	2000	2500	3000	Headroom	Total Height
	Guide Width	75	75	75	75	75		
Guide Height (mm)	1900	890	1039	1189	1346	1513	300	2200
	2150	935	1099	1225	1375	1548	300	2450
	2300	989	1134	1281	1402	1561	300	2600

STANDARD COLOURS



Powder coated guide rails and bottom slats to match the curtain colour are supplied as standard.

End Plates: Aluminium, white or brown as standard. Other colour options are available at a surcharge of **£24.60 per pair**.

Guides Rails: Other non standard colours available at **£36.76 per pair**.

PLEASE NOTE: Painted Woodgrains and Foiled Woodgrain Colours are not available on our SeceuroGlide Manual Garage Door.



KEY OPERATION

The key operated lock is located in the middle of the door. Integrated handles are located in the middle and at the bottom for convenient operation from inside or outside the garage.



SeceuroGlide Vertico: White Colour Finish



SeceuroGlide Vertico: White Colour Finish

Our lateral running door offers a unique and stylish solution for any garage design.

The Vertico makes the most of your garage space and creating a design feature for your home. Vertico is made from aluminium foam filled slats which link together to ensure exceptionally smooth operation and insulation, making the Vertico an ideal choice for heated garages and workshops. The vertical design offers partial opening ensuring minimal heat-loss and provides a convenient solution for pedestrian or bicycle access.

Configuration examples

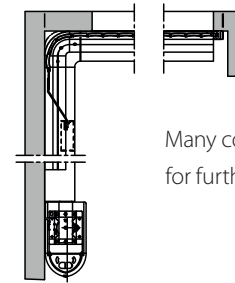

Many configurations are possible, for further examples, please scan the QR code.



Space Saving
Park next to door without affecting the door's operation.



Headroom
Only 50 mm of headroom required.



Insulated Slats
CFC-free foam-filled aluminium slat design.

Unit Width (mm)

Standard Colours	Unit Height (mm)	Unit Width (mm)																				
		2000	2200	2400	2600	2800	3000	3200	3400	3600	3800	4000	4200	4400	4600	4800	5000	5200	5400	5600	5800	6100
Standard Colours	2000	3457	3597	3668	3740	388	4031	4175	4246	4390	4463	4606	4745	4815	4955	5030	5169	5309	5379	5580	5780	6078
	2200	3531	3670	3743	3816	3956	4093	4236	4308	4449	4518	4657	4796	4865	4999	5070	5208	5346	5416	5614	5814	6113
	2400	3738	3882	3956	4027	4175	4320	4466	4535	4683	4759	4899	5050	5123	5272	5346	5492	5641	5715	5925	6139	6457
	2600	3863	4009	4078	4148	4290	4432	4576	4645	4791	4862	5006	5152	5223	5365	5441	5585	5729	5802	6019	6230	6554
	2800	4088	4236	4308	4381	4529	4676	4821	4896	5043	5113	5262	5412	5487	5634	5710	5858	6012	6083	6310	6532	6872
	3000	4246	4390	4463	4534	4679	4821	4964	5038	5182	5255	5399	5539	5607	5746	5820	5961	6100	6169	6399	6630	6970

STANDARD COLOURS

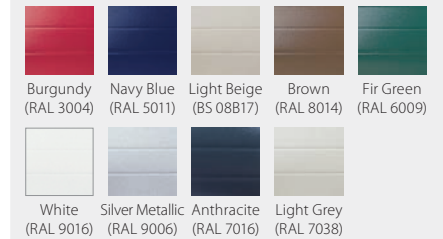

Creamy White, Aluminium Grey and Metallic Grey are also available – please enquire.

Top rail: White, Brown, Silver Metallic

VERTICO ACCESSORIES AND EXTRAS

IMAGE	DESCRIPTION	PROFILE	PRICE (£)	IMAGE	DESCRIPTION	PROFILE	PRICE (£)
ACCESSORIES				ACCESSORIES			
	Emergency safety release from outside, lockable per unit.	per unit	146.50		Additional hand transmitter (HS 2-M, 2 command 868 MHz)	per unit	107.66
	170x40mm extruded aluminium corner cover for reveal fix installation	per vertical M	43.10		Additional hand transmitter (HS 4-M, 4 command, 868 MHz)	per unit	180.11
	Window opening 50x150mm. Two super-imposed windows possible per slat CD77/SF, vision slat curtain with plexiglass inserts. Recommendation: Light-band/window opening: installation in every fourth slat in horizontal direction.	per window	34.53		Multi-function interior push button station with system plug. Functions:	per unit	357.10
	Coating design package: Special RAL coatings for guide channel, covers, turn radius and optional screen.	per unit	362.07		- Door status display, open-closed - Permanent lighting on-off - Operator, open-stop-close	per unit	138.10
					Surface-mounted key operated switch with system plug (29002/M) Flush-mounted version (29003/M)	per unit	136.53

SUPPLIED AS STANDARD WITH:

- Remote control motor unit including two transmitters
- Emergency unlocking from inside
- Galvanised floor rail

TECHNICAL OVERVIEW:

- Space requirement in the lintel area can be minimised to 50 mm
- Maximum unit width: 6100 mm
- Maximum unit height: 3050 mm
- Bottom track only 25 mm high
- Certified by TUV (Technical Inspection Authorities), produced according to DIN-EN safety standards

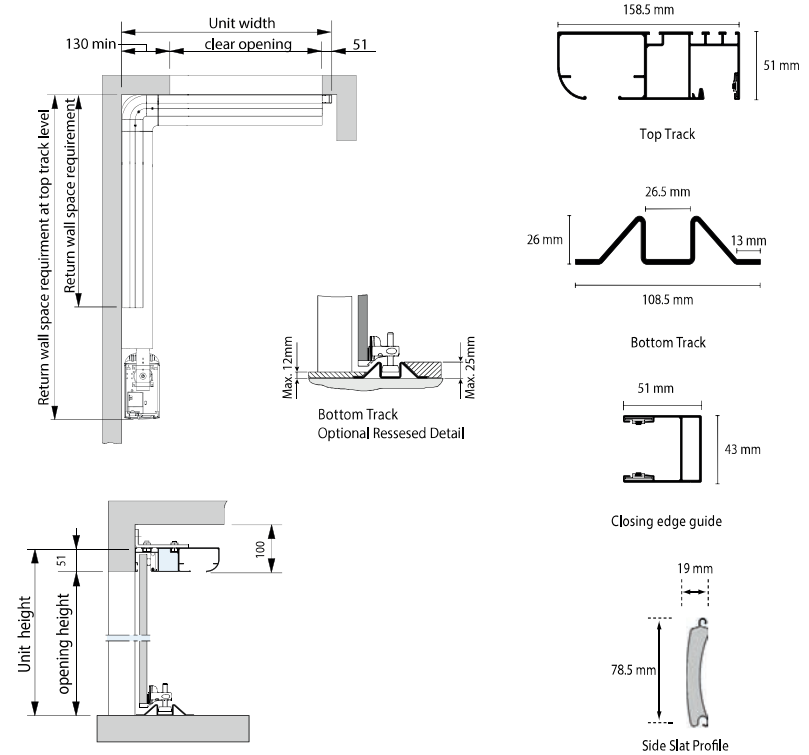

NOTES

COMPLIANCE WITH CURRENT LEGISLATION

- To ensure compliance with the Construction Products Regulation SeceuroGlide Compact must be installed with either a SeceuroSense Plus / Rollix remote control or a 'hold-to-run' switch or key switch.
- We recommend the use of photocells in addition to the standard bottom slat sensor in garages where a vehicle will be parked close to the door. Moreover, where a door opens directly onto a pavement or in a public area, a combination of bottom slat sensor and photocells is a statutory requirement.
- Antidrop devices are supplied when required at no extra cost.
- If ordering photocells retrospectively, the panel will need to be checked for compatibility. For more information please contact our Technical Support line on 01524 772 400.

COLOURS AND POWDER COATING

- Powder coated boxes, guides, bottom and locking slats may be a slightly different shade to the curtain.
- Other Renolit woodgrain finishes are available at the same cost as Mahogany, Rosewood, Golden Oak, White and Black/Brown, however longer lead times may apply. Please contact Customer Services for further details on 01524 772 400.
- SeceuroGlide Compact textured woodgrain doors are supplied with matching bottom slats and brown inner face, guides, end plates and half box as standard.
- SeceuroGlide Manual is NOT AVAILABLE in Woodgrain or Painted Woodgrain
- For woodgrain effect doors, any vision/vented slats will be supplied in a solid colour nearest to the colour of the woodgrain. Golden Oak will be supplied with brown. Vision slats are NOT available on the Compact or the Manual.
- Marking may occur at the top of the concave (coil) side of the curtain over time. This is unavoidable and due to prolonged contact with the locking system.
- Whilst the garage door profiles are primed and coated for the external environment – any doors fitted in coastal environments may be at risk of deterioration due to the weather conditions. Ensure you keep your door clean and follow the instructions for cleaning the door in the operating and maintenance instructions.
- Any Matched RAL colour garage doors are finished in a low gloss finish which is similar in gloss level to the pre-coated colours.

FITTING

- SeceuroGlide Excel must always be fitted internal face fitted / reveal fitted.
- When fitted externally SeceuroGlide Original will always be supplied with a full box.
- SeceuroGlide Compact external comes supplied with a full box.
- SeceuroGlide Manual can only be fitted internally.
- SeceuroGlide Manual is NOT AVAILABLE with box lid or fascia.
- A low level override option not available for SeceuroGlide Excel. Where the garage door is the only means of exit from a garage, a low level override can be supplied, however this will affect the Level 1 certification and SBD certification will not be supplied.
- If vented slats are selected as an option on SeceuroGlide Original or Excel, they will be supplied, however, this will affect the Level 1 and SBD accreditation and the security certification will not be supplied.
- Unless requested otherwise, when installed internally, tubular motors will be fitted on the left hand side of each door (when viewed from inside the garage looking out). Alternatively, unless requested otherwise, when installed externally, tubular motors will be fitted on the left hand side of each door (when viewed from outside the garage looking in).

SECURITY AND RESISTANCE TO HIGH WINDS

SeceuroGlide Original and Excel doors tested to a minimum Class 2 wind resistance classification, which is equivalent to 59mph winds (Force 10 Storm).

Please note: if a door is situated in an exposed location and subjected to very high winds and driving rain, the SeceuroGlide range does not guarantee against water ingress. As part of the product's testing for the CE marking, the product has not been tested against this and as such is classified as NPD (No Performance Declared)

OPTIONS & ACCESSORIES











IMAGE	DESCRIPTION	PROFILE	STOCK CODE	PRICE (£)
SECEUROSENSE HAND TRANSMITTERS				
	Plus 3 channel transmitter	each	EC71303	74.73
	Chrome 4 channel transmitter	each	EC71404	74.73
	Chrome Ellipse 4 channel transmitter	each	EC71004	74.73
	Chrome Deluxe 2 channel transmitter	each	EC71602	85.40
	Chrome Deluxe 4 channel transmitter	each	EC71604	85.40
	Smooth black 2 channel transmitter	each	EC71202	74.73
	Smooth black 4 channel transmitter	each	EC71204	74.73
	Smooth white 2 channel transmitter	each	EC71102	74.73
	Smooth white 4 channel transmitter	each	EC71104	74.73
	S/Sense Black Deluxe 2 channel transmitter	each	EC71702	£74.73
	S/Sense Black Deluxe 4 channel transmitter	each	EC71704	£74.73

IMAGE	DESCRIPTION	PROFILE	STOCK CODE	PRICE (£)
SECEUROSENSE WALL SWITCHES				
	4 channel black wall transmitter	each	EC73104	95.61
	4 channel white wall transmitter	each	EC73004	95.61
	4 channel stainless steel cover for wall transmitter	each	EC73000	39.56
	Wireless keypad	each	EC70300	228.58
SECEUROSENSE BIDIRECTIONAL CONTROLS				
	Smooth black 4 channel bi-directional transmitter	each	EC75104	90.11
	Smooth white 4 channel bi-directional transmitter	each	EC75004	90.11
	4 channel black bi-directional wall switch	each	EC74104	137.37
	4 channel white bi-directional wall switch	each	EC74004	137.37
SECEUROSENSE LIGHTING				
	Lighting strip external 1000 mm	each	EC76000	246.16
	Lighting strip external 2 x 1000 mm	each	EC77000	323.10
	Lighting Aluminium Cover 2000 mm	each	EC78000	91.22

OPTIONS & ACCESSORIES

















IMAGE	DESCRIPTION	PROFILE	STOCK CODE	PRICE(£)
SECEUROSENSE ACCESSORIES & OPTIONS				
	Tubular Motor Test Lead	each	EC40900	94.78
	Alarm Kit for SeceuroSense Plus	each	EC72300	85.72
	SeceuroSense Hard Wired Magnets (for uneven floors)	each	EC72600	51.65
	Upgrade to SeceuroSense External Bottom Slat Transmitter	each	YSGACCS1 EXTERNL	126.59
	SeceuroSense Photocell & Reflector	each	EC70500	94.51
ROLLIXO ACCESSORIES & OPTIONS				
	Somfy Smooove Origin RTS	each	EC37700	54.95
	Photocell cover	each	EC359T0	18.68
	Photocell and reflector	each	SG102P1	94.51
	Rollixio alarm kit	each	EC41001	21.98
	Keygo transmitters	each	SG100P0	76.05
	Situo 1 RTS Pure II Situo 1 RTS Iron II Situo 1 RTS Natural II Situo 1 RTS Arctic II	each	EC37800 EC37801 EC37802 EC37803	52.70 102.97 107.51 107.51
	Situo 5 RTS Pure II Situo 5 RTS Iron II Situo 5 RTS Natural II Situo 5 RTS Arctic II	each	EC37900 EC37901 EC37902 EC37903	76.67 103.42 137.93 137.93
	Somfy RTS Standard Receiver	each	SG103P0	87.49
	Battery Keygo transmitter	each	EC36100	5.42

IMAGE	DESCRIPTION	PROFILE	STOCK CODE	PRICE (£)
	Rollixio magnet	each	B5680M0	25.81
	Rollixio wireless keypad	each	SG101P0	223.14
OTHER CONTROL OPTIONS				
	Dual Pole Surface Mounted Geba Keyswitch Keyed Alike	each	EC381O3	77.35
	Dual Pole Surface Mounted Geba Keyswitch Keyed Different	each	EC381O2	76.61
	SO12 Flush Front Plate	each	EC381O4	6.88
OTHER OPTIONAL EXTRAS				
	Fitted manual override lock (SeceuroGlide Compact Only)	each	YSGACCS1 O/R LOK	136.18
	90 mm guides (upgrade from 75 mm guides)	per door	YSGACCS1 90 GUIDE	77.42
	SLOPING BOTTOM SLAT: Not available on Excel (please use order form) Overall door width from 0 to 5000 mm Online prices per linear metre @ £115.44 when specified with door	per linear metre	YACCS SLOPE	117.86
	SeceuroGlide Vision Slat (punched and glazed) Available Inline or Brick Bond	per linear metre	YSGACCS1 VISION	16.44
	SeceuroGlide Vented Slat* *Not available in Renolit or Painted Woodgrain finishes	per linear metre	SL777VS VENTED	50.52
	300 mm 90° fascia box support (4 required up to 3000 mm, 6 required – 3001 to 5400 mm)	each	BX000B0	7.27
	Emergency low level external manual override kit	each	MT120M1	197.79
	Loose manual override exit lock	each	MT018A1	56.20

OPTIONS & ACCESSORIES

IMAGE	DESCRIPTION	PROFILE	STOCK CODE	PRICE (£)
SECEUROGLIDE & SECEUROGLIDE COMPACT LATH REPLACEMENTS				
	SeceuroGlide cut Slat (Standard colours)	per metre	YSL770A1:1	11.43
	SeceuroGlide cut Slat (Woodgrain colours)	per metre	YSL770AL:1	18.25
	SeceuroGlide Compact cut Slat (Standard colours)	per metre	YSL300A1:1	5.31
	SeceuroGlide Compact cut Slat (Woodgrain colours)	per metre	YSL302AL	17.55
SECEUROGLIDE CURTAINS				
	SECEUROGLIDE READY MADE CURTAIN (The surcharge does not include the cost of safety edge this needs to be added on (cut out for the RDU is included if needed))	per metre square	SGLIDE CD77 CURT WOODGRAIN	160.88 201.02
	Standard colours Woodgrain			
	SECEUROGLIDE COMPACT READY MADE CURTAIN (The surcharge does not include the cost of safety edge this needs to be added on (cut out for the RDU is included if needed))	per metre square	CURT CD300 WOODGRAIN	138.63 174.20
	Standard colours Woodgrain			
ALUMINIUM BOX AND ANGLES				
	30 x 20 Powder Coated aluminium L section angle (Brown/White)	per metre	YSGACCS1 30X20	9.83
	50 x 20 Powder Coated aluminium box section/packer (Brown/White)	per metre	YSGACCS1 50X20	18.26
	50 x 50 Powder Coated aluminium box section/packer (Brown/White)	per metre	YSGACCS1 50X50	22.86
TOUCH-UP PAINT POT & PEN				
	TOUCH-UP PAINT POT Anthracite (RAL7016), Black (RAL9005), Brown (RAL8014), Burgundy (RAL3004), Duck Egg Blue, Chartwell Green (B514C35), Fir Green (RAL6009), Graphite (RAL7024), Heritage Green (RAL6021), Ivory (RAL1015), Light Beige (B508B17), Light Grey (RAL7038), Navy Blue (RAL5011), Silver Metallic (RAL9006), White (RAL9016)	each	PC501A0	6.22
	TOUCH-UP PAINT PEN Anthracite (RAL7016), Black (RAL9005), Brown (RAL8014), Burgundy (RAL3004), Light Beige (B508B17), Light Grey (RAL7038), Silver Metallic (RAL9006)	each	PC502P	24.94
SUNDRY SPARES				
	Sticky Backed Brush Strip (Monkey Fur)	per metre	GU031B0	4.40

IMAGE	DESCRIPTION	PROFILE	STOCK CODE	PRICE (£)
SPARES AND UPGRADES				
	SS Plus Receiver Unit - Wireless	each	EC89100	189.33
	SS Plus Receiver Unit - Wireless IP / External BST	each	EC89200	189.33
	SS Plus Receiver Unit - Wired	each	EC89300	189.33
	SecuroSense Bottom Slat Transmitter 1.5v	each	EC75100	119.78
	Duracell Batteries for SeceuroSense Bottom Slat Transmitter 1.5v	each	EC75101	1.98
	3.6v Lithium Battery For SeceuroSense (2pk)	each	EC71101	28.58
	Radio Card for 3.6v BST	each	EC79900	128.38
	Radio Card for 3.6/1.5v BST	each	EC79800	128.38
	Rollixo Receiver & 2 Keygo Transmitters	each	EC46000	344.68
	Rollixo XSE Bottom Slat Transmitter	each	B5680B0	£119.78
	Replacement Light Bulb for SeceuroSense Courtesy Light	each	EC72500	4.40
	Batteries for SeceuroSense Transmitters (CR2032)	each	EC36101	5.49
UPGRADE KITS				
	SS Plus Wireless Upgrade Kit SS Plus Wired Upgrade Kit	each	EC69902 EC69903	355.44
	Somfy Rollixo Garage Door Remote Control Upgrade Kit	each	EC49900	360.45
	AEGDW Bottom Slat	each	YB5005E1	27.87
	Triple Chamber Rubber Seal	each	B5730B0	17.58
	Radio Card & BST Upgrade Kit	each	EC99000	251.75

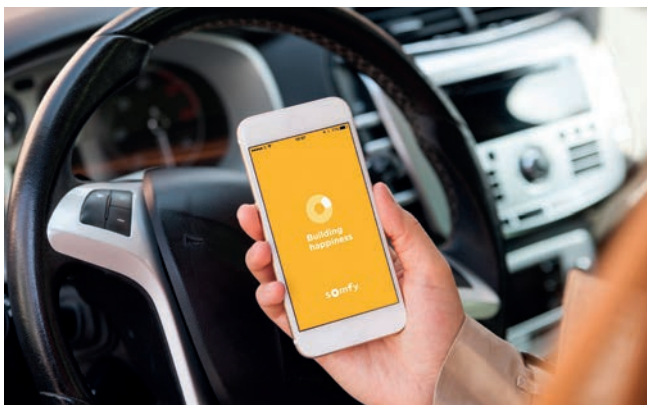

With Home Automation you can put yourself in control of securing your world, even when you are miles away from home.

A SMART WAY OF LIVING

Monitor and operate lights, home surveillance and garage doors with your smartphone or tablet, for great peace of mind from anywhere in the world. Personal to You With the bespoke style of your SeceuroGlide garage door, you can adjust everything about the Home Automation system to accommodate your personal preferences.

CONVENIENT FROM THE BEGINNING

Your customers will be able to secure their home with the touch of a button via Somfy Connexoon, and if they upgrade to a Somfy TaHoma hub they can add extras in the future, such as surveillance cameras, motion detectors and climate control.

WHICH SYSTEM IS FOR ME?

- Connexoon is a home automation starter kit which can control your garage door and fulfil basic commands.
- TaHoma is a fully integrated home automation system, enabling you to take full control of your garage, blinds, lighting, heating and security system.

KEY FEATURES

- Control your home from anywhere using TaHoma
- Improve security and safety at home
- Geo-Location ringfencing (Connexoon only)
- Multi-function control
- Integrate with your family routine
- Create scenarios for different requirements throughout your home

COMPATIBLE DEVICES

Your Home Automation with SWS UK and Somfy can be compatible with multiple devices, including:



SOMFY HOME AUTOMATION ACCESSORIES
(more options available online)

IMAGE	DESCRIPTION	COMPATIBLE WITH:	STOCK CODE	PRICE (£)
	Connexoon RTS	N/A	EC462CX	183.97
	TaHoma	N/A	EC461TM	377.64
	Garage Door Sensor	TaHoma	EC465GD	173.19
	RTS Plug	TaHoma Connexoon	EC466PL	37.96
	Water Sensor	TaHoma	EC467WS	138.55
	Indoor Camera	Somfy Protect app	EC470IC	288.66
	Indoor Siren	TaHoma	EC473IS	130.86
	Outdoor Motion Sensor	TaHoma	EC474OM	523.45
	Smoke Detector	TaHoma	EC481SM	130.86
	Temperature Sensor	TaHoma	EC482TS	173.85
	Outdoor Camera (White)	Somfy Protect app	EC471CW	559.04

DELIVERY, PACKING & WARRANTIES

DELIVERY SERVICE

Our standard delivery service covers England and Wales weekly, Scotland and Ireland fortnightly.

Pricing includes delivery on all orders over £400 on our standard weekly service to England and Wales. Additional chargeable deliveries can often be arranged with Customer Services. We also offer home/site delivery service options with one or two men depending on the size of delivery and site conditions.

Delivery confirmations for our own dedicated service will be emailed or texted the previous afternoon if AM or PM the following working day. Please ensure an email address and/or mobile number is supplied on your order.

DELIVERY CHARGES

	£
Over £400 net on standard run	Nil
Under £400 net on standard run	£43.50
All orders required on a different day to standard delivery run	POA
Collection from distribution depot	Nil
Site delivery charge one man offload	£64.00 extra
Site delivery charge two man offload	£105.00 extra
Redelivery of goods	£40.00 extra
Deliveries to Scotland	£38.00 per drop
Deliveries to Ireland	£88.00 per drop

CARRIER SERVICES PRICE

	£
Component items up to 5 kg (Including singular tube motors)	£13.50
Component items up to 20 kg	£33.00
Delivery & packaging of fragile items over 20 kg	£73.00
Pre 10.30 am	£42.00 extra
Pre noon	£31.00 extra
Saturday pre noon	£52.00 extra

Additional surcharges apply on the following:

Ireland, Isle of Man, Channel Islands & Scottish offshore	POA
Isle of Wight	POA
Grampian & Highlands	POA
Devon & Cornwall	£14.00

For urgent orders in certain areas of the country, collection is possible from our 3 distribution depots (must be collected within 24 hours):

South (Heathrow)

Units 2, 3 & 4, Lakeside Industrial Estate,
Lakeside Road, Colnbrook SL3 0ED

Midlands (Willenhall)

DX Freight, Unit 1 Bays 1, 2, 3 East Acre,
Off Long Acre, Willenhall WV13 2JZ

Bristol

Jupiter Road, Patchway, Bristol BS34 5BW

COMPONENT ORDERS

All small component orders required next day must be received by 2 pm the day before delivery. Orders placed on a Friday must be received by 12 noon for delivery on Monday.

If you require powder-coated items, please allow an additional 24 hours at least from the receipt of order. Items for assembly need to be booked in for manufacturing – for example complete shutter curtains. Please allow a minimum of three working days depending on the delivery method.

Regrettably it is not possible to send items over 5 m in length by overnight carriers.

IMPORTANT DELIVERY NOTE

The most cost effective and safest way of delivering orders is via our own transport. Please try to tie orders in with your normal delivery runs wherever possible.

In the event of using a carrier, we need to use reinforced packaging.

CRATE CHARGES

We can offer delivery by crate on a POA basis. Please speak to Customer Services.

SECEUROGLIDE COMPLIANCE WITH THE LATEST CE STANDARDS

The SeceuroGlide range is fully compliant with the latest European product directives and standards including BSEN 13241-1 applicable from the 1st May 2005.

APPROVED SUPPLIER:

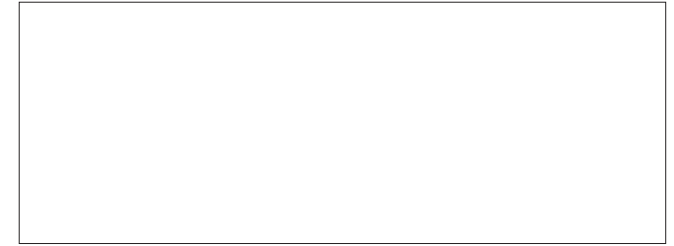

SECEUROGLIDE PEACE-OF-MIND WARRANTIES

SeceuroGlide Excel, SeceuroGlide Original, SeceuroGlide LT, SeceuroGlide Compact and SeceuroGlide Manual are guaranteed against defect of material or workmanship by SWS UK with a parts only warranty for a period of 5 years from the date of purchase, subject to correct installation, maintenance and operation. Our standard SeceuroDrive motor carries a 7 year warranty, subject to registration (<https://warranty.sws.co.uk>) within 3 months of installation (excluding LT). If a SeceuroDrive motor is paired with a SeceuroSense Plus receiver it will also be eligible for a 7 year warranty. In addition, Rosewood, Mahogany, Golden Oak, White, Black / Brown and our full range of Renolit wood effect finishes carry a limited 10 year guarantee on the slat finish.

SeceuroGlide Vertico is guaranteed for a period of 2 years from the date of purchase, subject to correct installation, maintenance and operation.

Please note darker coloured double doors that are exposed to significant direct sunlight may be susceptible to expansion which may interfere with the operation of the door.

SECEUROGLIDE EXTREME WEATHER CONDITIONS

High winds and high temperatures can cause increased deflection of the door. It is the installer's responsibility to ensure that the door is packed off the wall sufficiently to allow for door movement during these extreme weather conditions.

SWS UK is proud to be an official supporting supplier of The Association Of Garage Door Specialists. In line with SWS UK's policy of continuous product development, we reserve the right to make changes without prior notification. All information is believed correct at the time of publication, errors and omissions excepted.

CALCULATING SIZE AND PRICE

Drive Through & Total Sizing:

- Drive through width = Over guide width minus (guide width x 2)
- Drive through height = Guide height minus hangdown
- Total/overall height = Guide height plus headroom

	Width Priced on over guide width				Height Priced on guide height		
	Guides				Hangdown	Headroom	
	Up to 3000	Up to 4600	Up to 5200	Up to 5590		Up to 2500	Up to 3500
Excel	90	90	90		110	300	350
Original	75	75	90	90	110	300	350
LT	75	75	90		110	300	
Compact	60				50	205	
Manual	75				105	300	

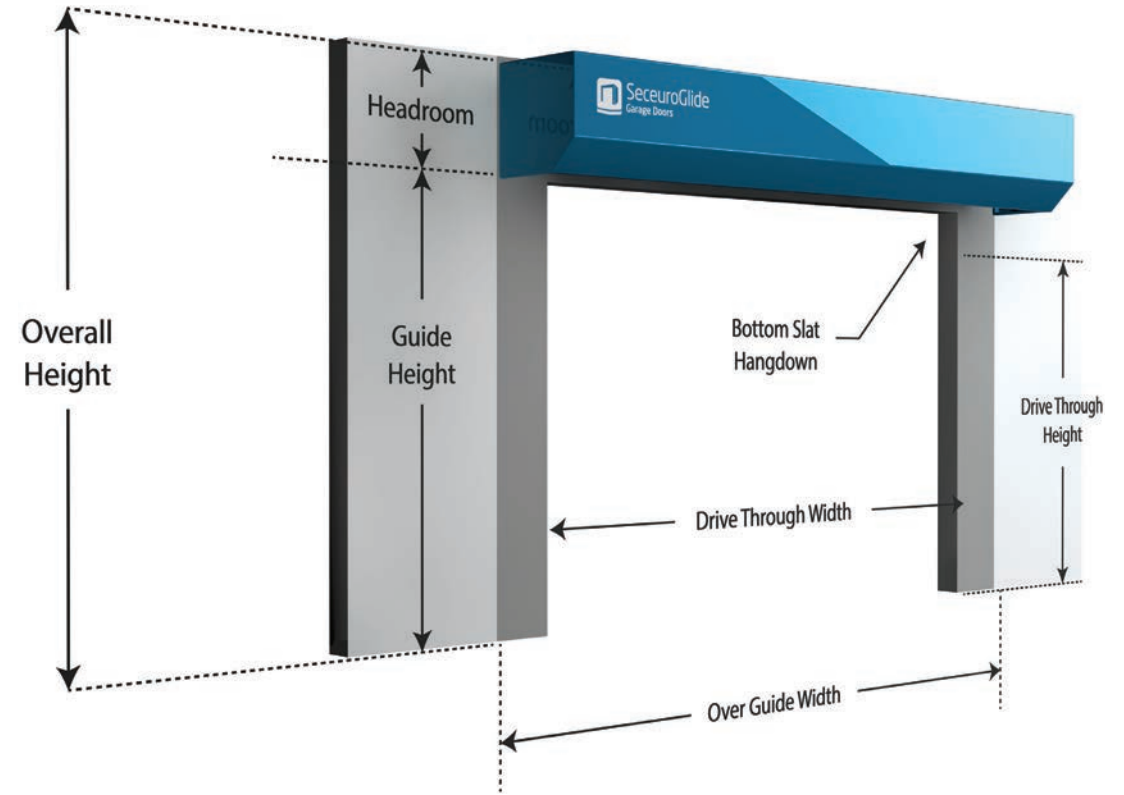

Minimum and maximum sizes across the range:

	Over guide width (mm)		Guide Height (mm)	
	Min	Max	Min	Max
Excel	1500	5200	1500	3500
Original	1050	5590	1500	3700
LT	1050	5200	1500	2650
Compact	1050	3000	1700	2150
Manual	1000*	3000	1500	2300

*Minimum width above 2150 mm guide height = 1100 mm

